

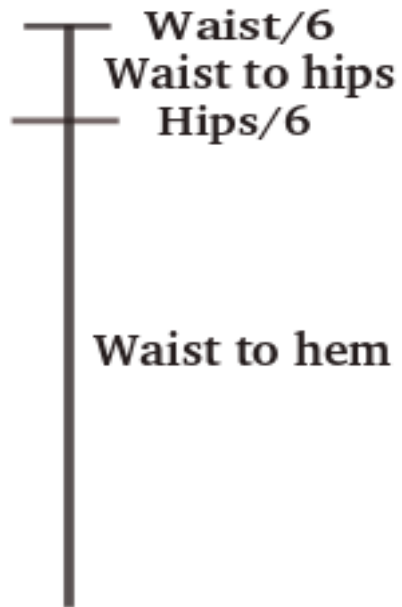

**Gored Skirt**

# How to Draft a Six-Gore Skirt Pattern

1.



2.

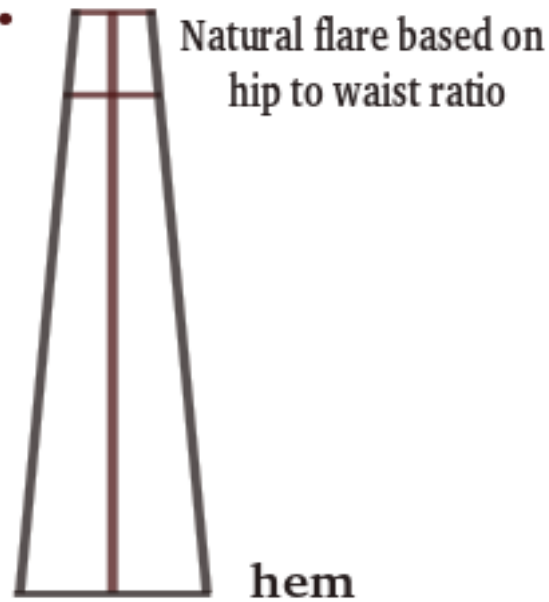

3.

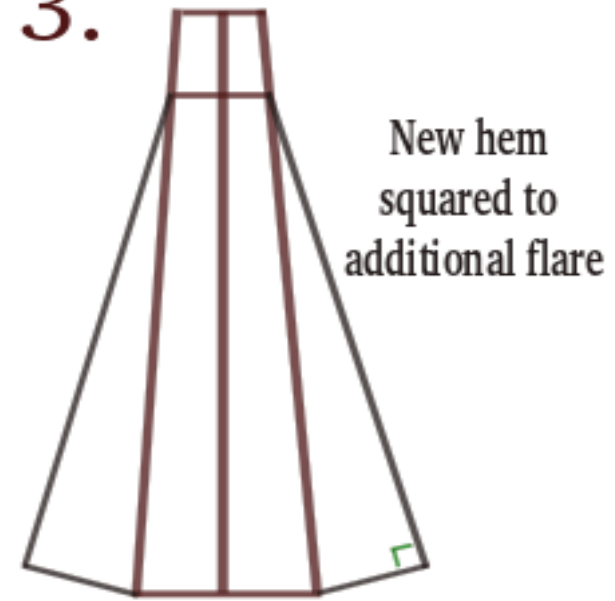

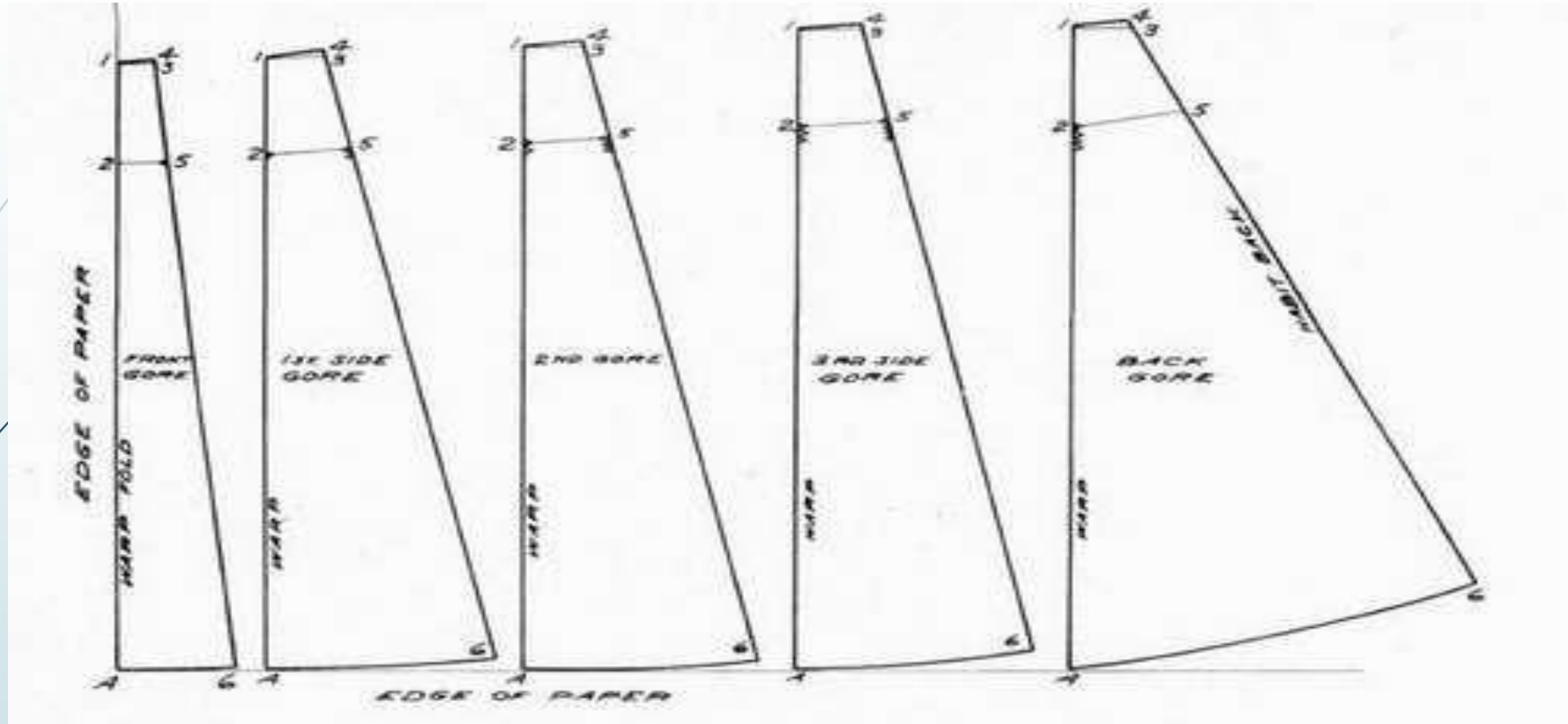

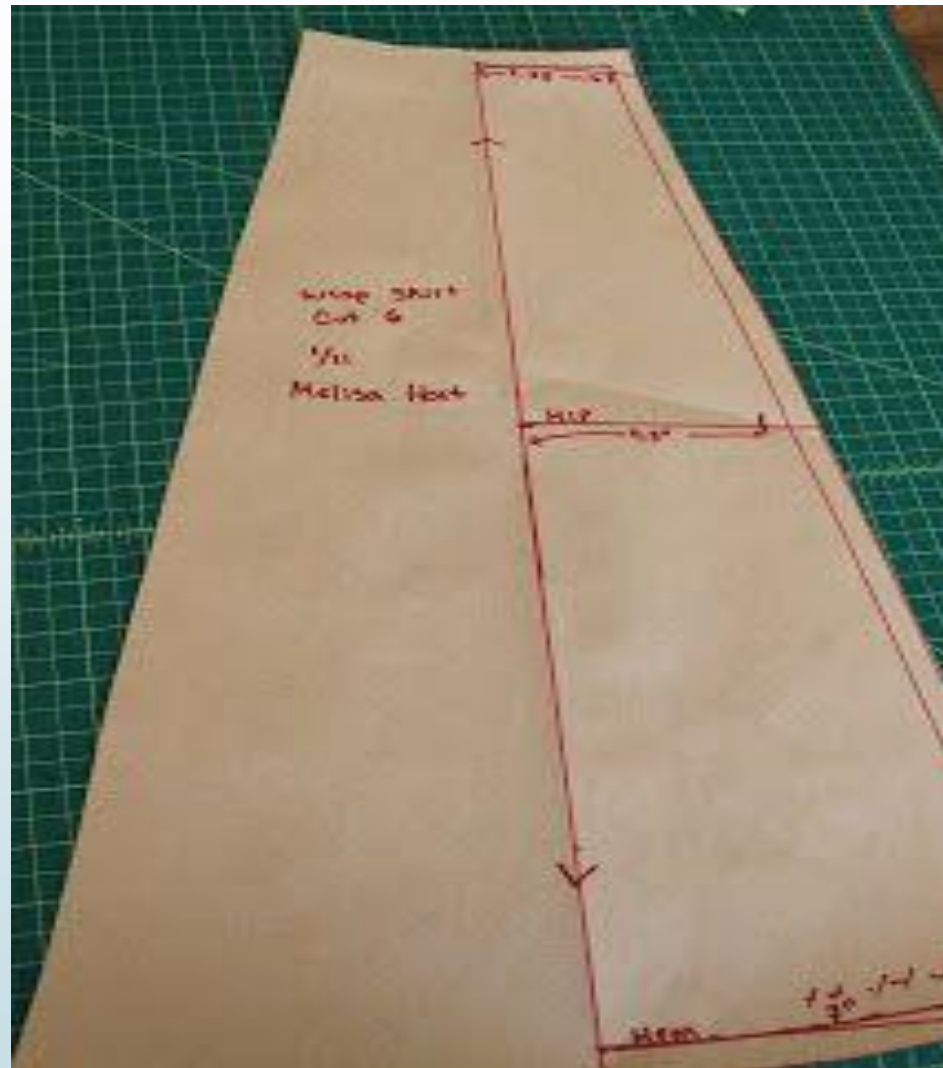
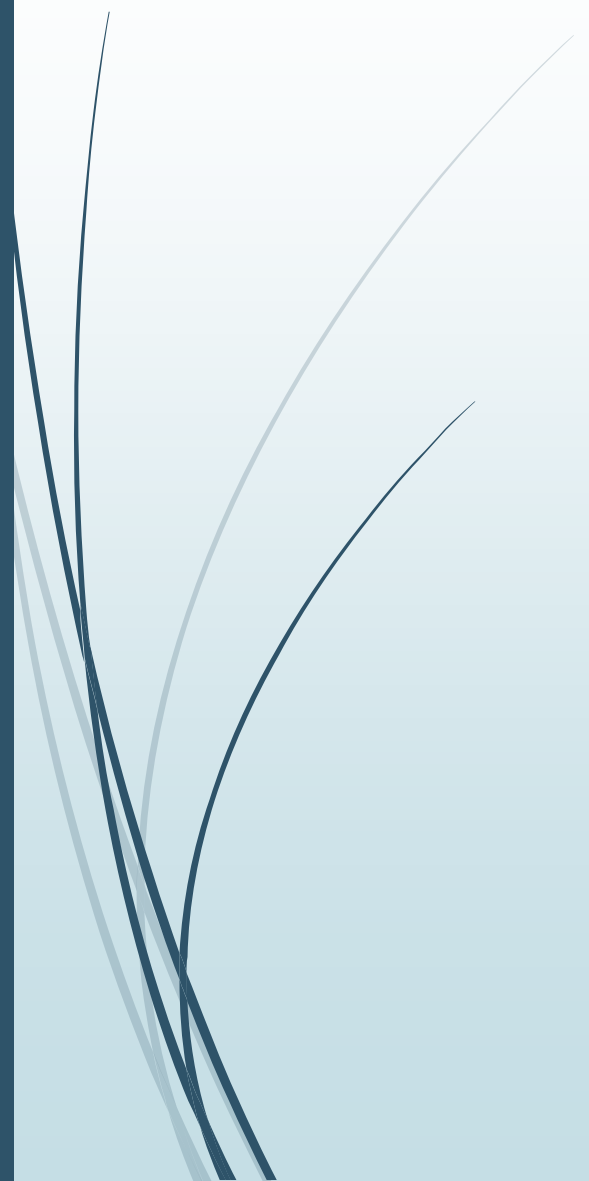

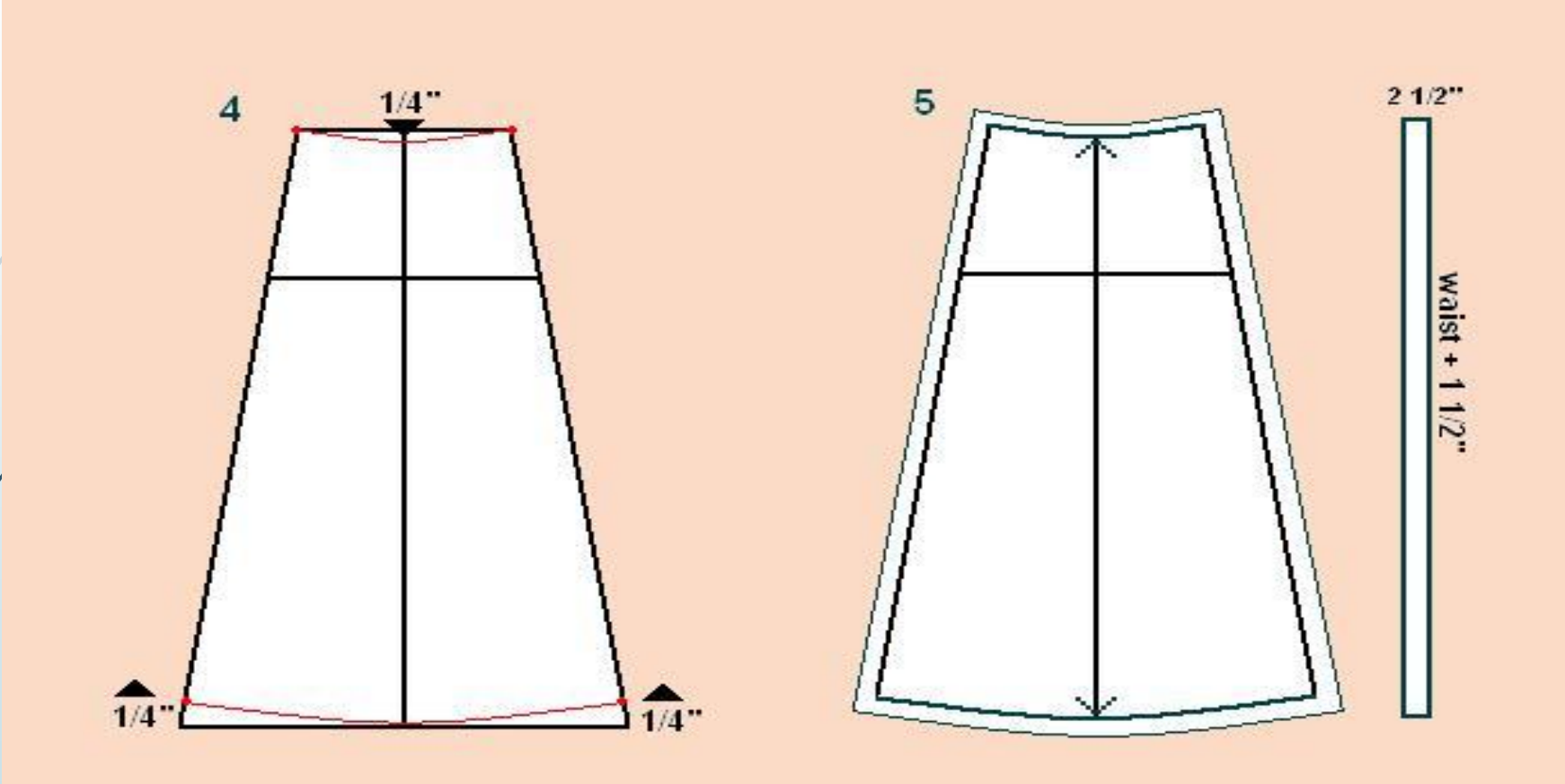



**Thank You**